



PRO AS20P



PRO AS30P



PRO AS40P

# SERVICE MANUAL

# CONTENTS

|                                   |   |
|-----------------------------------|---|
| <b>SAFETY PRECAUTIONS</b> .....   | 2 |
| <b>INSTRUCTION MANUAL</b>         |   |
| • Getting started .....           | 3 |
| <b>BASIC MAINTENANCE</b>          |   |
| • Cleaning the ozone module ..... | 6 |
| • Cleaning the fan filter .....   | 8 |

**Congratulations on your purchase of the MedKlinn PRO AS 20P/30P/40P Air Sterilizer!** It incorporates the most innovative and latest air cleaning technology, the **Cerafusion™ Technology**. Please read the following instructions carefully before using the unit. With a little care, it will provide you with many years of clean, fresh and healthy air in any indoor environment.

## **SAFETY PRECAUTIONS**

### **! WARNINGS - *To reduce the risk of electrical shock, fire or injury:***

1. Do not use the unit if the power cable or plug is damaged.
2. Do not insert any sharp or pointed object through the ventilation holes of the unit.
3. Do not allow unauthorized personnel to meddle with the unit.
4. Do not immerse the unit in water, or allow water or any fluids to enter through the ventilation holes.
5. When removing the power plug, always hold the plug and never pull the cable.
6. Do not remove the power plug when your hands are wet.
7. Remove the power plug from wall socket before cleaning the unit.
8. Do not modify, disassemble or repair this unit without proper training unless stated in the manual.
9. Do not replace the electric plug or cut the power cable. Replacing the plug or cutting the power cable in any way will immediately cause the warranty to become void, and repair and servicing will be chargeable.
10. If the power cable is damaged, contact an authorized MedKlinn Service Centre for repair immediately.
11. Do not attempt to open the unit for any other purposes except to clean the module and inner compartment. The unit requires minimal maintenance, and no servicing or repairs are to be carried out by the user. Opening the device or tampering with it in any way will cause the warranty to become void. If you encounter any problems with the unit, please contact the nearest authorized dealer or distributor.
12. Do not clean the unit with benzene or paint thinner.

**NOTE: Radio or TV Interference:**

If the unit should cause interference to radio or television reception, try to correct the interference by one or more of the following measures:

1. Reorient or relocate the receiving antenna.
2. Increase the distance between the unit and radio/TV receiver.
3. Connect the equipment to an outlet on a circuit different from that to which the receiver is connected.
4. Consult dealer or an experienced radio/TV technician for help.

** CAUTIONS DURING OPERATION**

1. Place the unit at least 6 feet from radio, television or electronic equipment. This is to minimize the possibility of interference with the equipment or the remote controller.
2. Do not cover the unit in any way at all, particularly the ventilation holes. Doing so will cause excessive heat build-up and may result in a fire and irreparable damage to the unit.
3. Avoid placing the unit where curtains or other furnishings may cover the ventilation holes.
4. Avoid placing the unit in an oily environment as it may cause the module to be coated with a thicker layer of grease/debris, hence, affecting its performance.
5. Ensure that there is air flow around the unit.
6. Avoid locations where the unit is exposed to condensation due to rapid and drastic temperature fluctuations. The unit should only be used in temperatures between 5-35° C.
7. Effective cleaning by negative ions and ozone requires adequate air exchange as they are created from oxygen, regular air exchange will take place if the door or window is opened occasionally.
8. Do not use in small enclosed spaces where there is no or poor air circulation e.g. in wardrobes, closets or pantries.
9. Negative ions and ozone are very reactive, and they may cause discoloration to poorly painted surfaces. To minimize this, do not place the unit directly against walls or other painted surfaces, and leave a space of a least one (1) foot from these surfaces.
10. It is NOT recommended to place the unit directly too close to pets.

# INSTRUCTION MANUAL

PRO AS20P/30P/40P

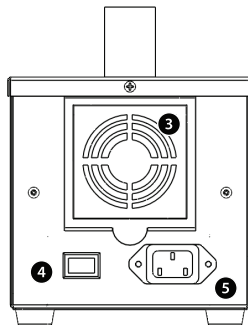
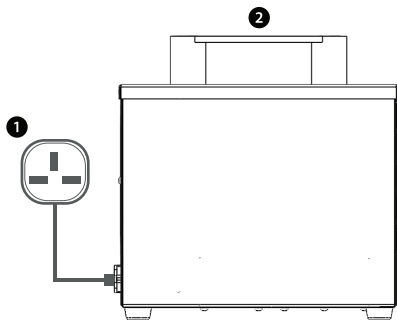

- ① Power cord
- ② Handle
- ③ Fan filter

- ④ ON/OFF switch
- ⑤ Power cord connector

## GETTING STARTED

Plug in one end of the power cord into the power cord connector at the right side of the unit.

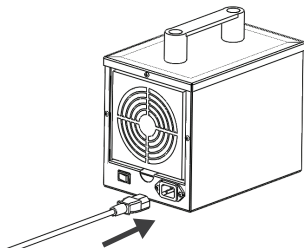

Plug in the other end of the power cord into the 110V-240V AC power outlet and switch on the power outlet.



Thailand



U. S.

### Proper grounding for International plugs

For safety precaution, International plugs use must have proper grounding wire connected to the unit.



Press the **ON/OFF** switch to turn on the unit

The switch will light up when it is in the ON position

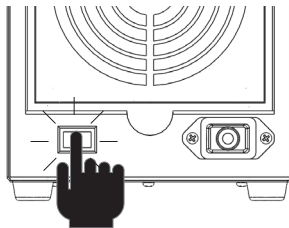

**Both the fan and the ozone module are activated when the unit is turned on**

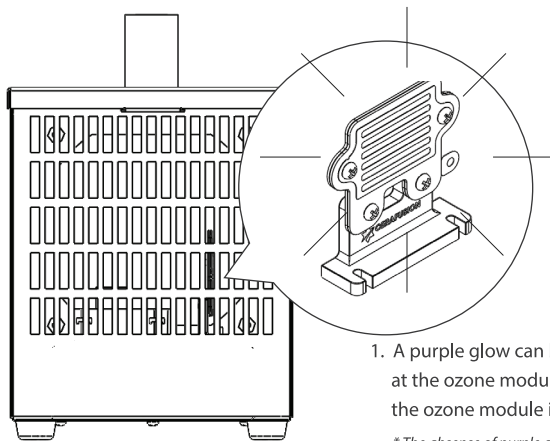

1. A purple glow can be seen forming at the ozone module plates when the ozone module is functioning

*\*The absence of purple glow indicates the ozone module plates need to be cleaned*

## BASIC MAINTENANCE

### Cleaning Ozone Module: Basic Cleaning

1. Turn off the AC power outlet. Make sure that the ON/OFF switch is not lighted up.
2. Remove the top cover screw with a screwdriver.
3. Lift up the top cover to access the inner compartment of the unit.
4. Brush the ozone module plate(s) using a hard brush.
5. Wipe the entire inner compartment.
6. Re-attach the top cover.
7. Power up the unit only when the ozone module and inner compartment are fully dried.

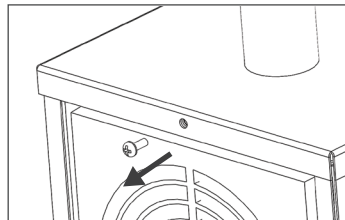

2. Remove the top cover with a screwdriver

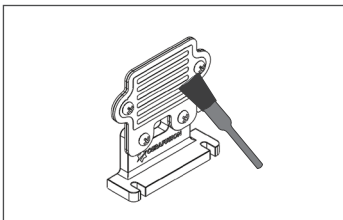

4. For PRO AS 20P, brush the 1 side of the Ozone module plates. For PRO AS 30P/40P, brush the 2 sides of the Ozone module plates.

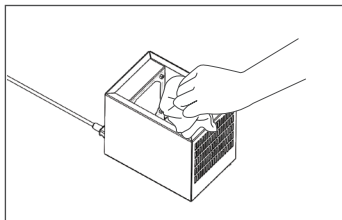

5. Wipe the entire inner compartment.



## BASIC MAINTENANCE

### Cleaning Ozone Module: Advanced Cleaning

1. Turn off the AC power outlet. Make sure that the ON/OFF switch is not lighted up.
2. Remove the top cover screw with a screwdriver.
3. Using a M3 nut driver, loosen both nuts which lock the ozone module to the unit casing.
4. Brush the ozone module plate(s) using a hard brush.
5. Wipe the entire inner compartment.
6. Lock the ozone module and re-attach the top cover.
7. Power up the unit only when the ozone module and inner compartment are fully dried.

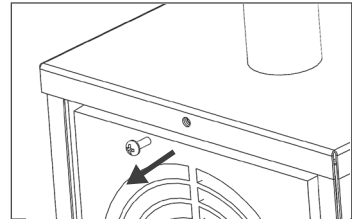

2. Remove the top cover with a screwdriver

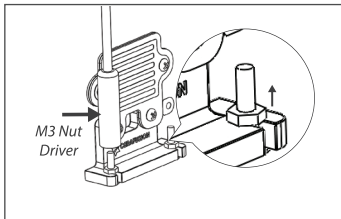

3. Using a M3 nut driver, loosen both nuts which locking the ozone module to the unit casing.

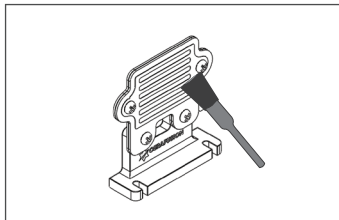

4. For PRO AS 20P, brush the 1 side of the Ozone module plates. For PRO AS 30P/40P, brush the 2 sides of the Ozone module plates.

## Cleaning The Fan Filter

1. Turn off the AC power outlet. Make sure the ON/OFF switch is not lit.
2. Remove the fan filter by pulling out the filter cover.
3. Rinse and dry the separate parts of the fan filter.
4. Wipe the filter mesh of the fan gently with a damp cloth.
5. Assemble the fan filter in proper order and reattach it to the fan.
6. Clean the fan filter once a month or when it is clogged up with dirt / dust which may affect optimal performance.  
(A clogged up filter will damage the fan)

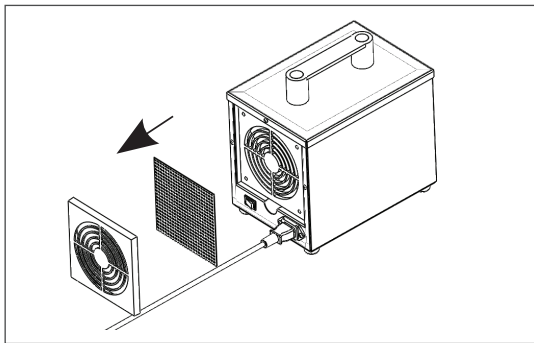

2. Remove the fan filter by pulling out the filter cover.

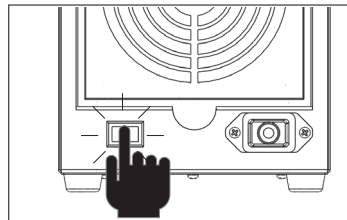

1. Turn off the AC power outlet. Make sure that the ON/OFF switch is not lit up.

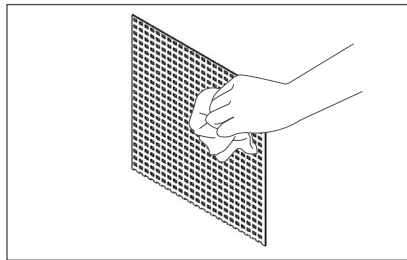

4. Wipe the filter mesh of the fan gently with a damp cloth

*For more information, please log on to [www.medklinn.com](http://www.medklinn.com)*

greenpages  
malaysia

Driven by  
 **CERAFUSION™**  
Technology



